



EN Operating instructions.pages 1 to 6
Translation of the original operating instructions

Content	
1	About this document
1.1	Function 1
1.2	Target group: authorised qualified personnel. 1
1.3	Explanation of the symbols used 1
1.4	Appropriate use 1
1.5	General safety instructions 1
1.6	Warning about misuse 1
1.7	Exclusion of liability 2
2	Product description
2.1	Ordering code 2
2.2	Special versions. 2
2.3	Destination and use 2
2.4	Technical data 2
2.5	Safety classification 2
3	Mounting
3.1	General mounting instructions 2
3.2	Dimensions 3
4	Electrical connection
4.1	General information for electrical connection. 3
4.2	Contact variants 4
5	Set-up and maintenance
5.1	Functional testing. 4
5.2	Maintenance 4
6	Disassembly and disposal
6.1	Disassembly. 4
6.2	Disposal 4
7	Appendix
7.1	EC Declaration of conformity 5

1. About this document

1.1 Function

This operating instructions manual provides all the information you need for the mounting, set-up and commissioning to ensure the safe operation and disassembly of the safety switchgear. The operating instructions must be available in a legible condition and a complete version in the vicinity of the device.

1.2 Target group: authorised qualified personnel

All operations described in this operating instructions manual must be carried out by trained specialist personnel, authorised by the plant operator only.

Please make sure that you have read and understood these operating instructions and that you know all applicable legislations regarding occupational safety and accident prevention prior to installation and putting the component into operation.

The machine builder must carefully select the harmonised standards to be complied with as well as other technical specifications for the selection, mounting and integration of the components.

1.3 Explanation of the symbols used



Information, hint, note:
This symbol is used for identifying useful additional information.



Caution: Failure to comply with this warning notice could lead to failures or malfunctions.
Warning: Failure to comply with this warning notice could lead to physical injury and/or damage to the machine.

1.4 Appropriate use

The products described in these operating instructions are developed to execute safety-related functions as part of an entire plant or machine. It is the responsibility of the manufacturer of a machine or plant to ensure the correct functionality of the entire machine or plant.

The safety switchgear must be exclusively used in accordance with the versions listed below or for the applications authorised by the manufacturer. Detailed information regarding the range of applications can be found in the chapter "Product description".

1.5 General safety instructions

The user must observe the safety instructions in this operating instructions manual, the country-specific installation standards as well as all prevailing safety regulations and accident prevention rules.



Further technical information can be found in the Schmersal catalogues or in the online catalogue on the Internet: www.schmersal.net.

The information contained in this operating instructions manual is provided without liability and is subject to technical modifications. There are no residual risks, provided that the safety instructions as well as the instructions regarding mounting, commissioning, operation and maintenance are observed.

1.6 Warning about misuse



In case of improper use or manipulation of the safety switchgear, personal hazards or damages to machinery or plant components cannot be excluded when safety switchgear is used.

1.7 Exclusion of liability

We shall accept no liability for damages and malfunctions resulting from defective mounting or failure to comply with this operating instructions manual. The manufacturer shall accept no liability for damages resulting from the use of unauthorised spare parts or accessories.

For safety reasons, invasive work on the device as well as arbitrary repairs, conversions and modifications to the device are strictly forbidden; the manufacturer shall accept no liability for damages resulting from such invasive work, arbitrary repairs, conversions and/or modifications to the device.

2. Product description

2.1 Ordering code

This operating instructions manual applies to the following types:

ZQ 900-①②

No.	Option	Description
①	11	1 NO contact / 1 NC contact
	13	1 NO contact / 3 NC contacts
	22	2 NO contacts / 2 NC contacts
	02	2 NC contacts
②	04	4 NC contacts
	N	without emergency-stop button with emergency-stop button



Only if the information described in this operating instructions manual are realised correctly, the safety function and therefore the compliance with the Machinery Directive is maintained.

2.2 Special versions

For special versions, which are not listed in the order code below 2.1, these specifications apply accordingly, provided that they correspond to the standard version.

2.3 Destination and use

Pull-wire emergency stop switches are used on machinery and plants, where triggering the emergency stop command must be enabled at arbitrary points on the wire run. If the tensioned pull-wire is pulled or in case of wire breakage or if the optional emergency stop switch is pushed, the switching function of the pull-wire emergency stop switch is activated. (refer to image 1).

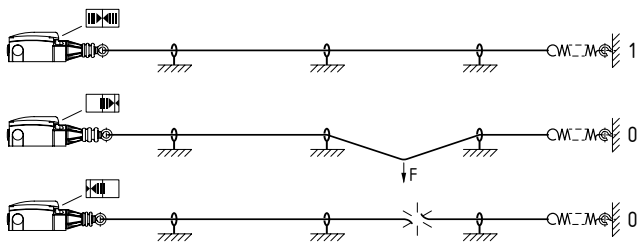

Image 1: position indication and actuation

Design/operating principle

The pull-wire emergency stop switches of the ZQ 900 series are brought into the operational condition by the proper pre-tensioning of the wire. Up to two switching elements located on the inside of the switch have either 2 or 4 contacts, whereby the NC contacts are closed and the NO contacts are opened in tensioned condition.

After actuation of the emergency stop function, a latching mechanism maintains the stop command until the switch is released by pushing the blue reset button. Prior to the reset of the emergency stop signal, the reason why the switch has been actuated must be determined. The switch can only be reset if the switch is correctly pre-tensioned (position indication in central position, refer to image 1).



The entire concept of the control system, in which the safety component is integrated, must be validated to the relevant standards.

2.4 Technical data

Standards:	IEC 60947-5-1, IEC 60947-5-5, ISO 13850
Enclosure:	GD-Zn alloy, paint
Cover:	thermoplastic
Protection class:	IP65, IP67 to IEC 60529
- ZQ 900-...-N:	IP65
Contact material:	Silver
Switching system:	Change-over contact with double break, 1 to 4 NC contacts; snap action with positive break NC contacts
Connection:	screw terminals
Cable section:	max. 2.5 mm ² (incl. conductor ferrules)
Cable entry:	3 x M20x1.5
Rated impulse withstand voltage U _{imp} :	6 kV
Rated insulation voltage U _i :	500 V
Thermal test current I _{me} :	6 A
Rated operating current/voltage I _e /U _e :	4 A / 230 VAC, 1 A / 24 VDC
Utilisation category:	AC-15, DC-13
Max. fuse rating:	6 A gG D-fuse (EN 60269-1)
Ambient temperature:	-25 °C ... +70 °C
Wire length:	max. 75 m depending in relation to the range of ambient temperature (see image 3)
Mechanical life:	>1 million operations



Input terminal wire size AWG: 14-22
Max. Torque: 7 Lb In
Use solid or stranded copper conductors only.

2.5 Safety classification

Standards:	EN ISO 13849-1
B _{10d} NC contact:	100,000
Service life:	20 years

$$MTTF_d = \frac{B_{10d}}{0,1 \times n_{op}} \quad n_{op} = \frac{d_{op} \times h_{op} \times 3600 \text{ s/h}}{t_{cycle}}$$

(Specifications can vary depending on the application-specific parameters h_{op} , d_{op} and t_{cycle} as well as the load.)

3. Mounting

3.1 General mounting instructions

The installation may only be carried out by authorised personnel. The pull-wire emergency stop switch is fitted by means of two screws (distance of the drill holes 40 mm or 48 mm), so that a release by hand can be realised without hazard. The component must be fitted so that the entire length of the wire can be viewed from the position of the switch.



In accordance with IEC 60947-5-5, the maximum perpendicular traction force to be exercised on the wire in order to activate the emergency pull-wire switch is 200 N, the maximum deflection is 400 mm. Sufficient space must be provided so that the required actuating deflection can be reached.

For tensioned span lengths up to 10 m, intermediate wire supports are required every 3 to 5 m. To avoid resonance vibrations in the wire on machines with high vibrations, it is recommended to realise the individual support length differently. Assembly: refer to image 2.

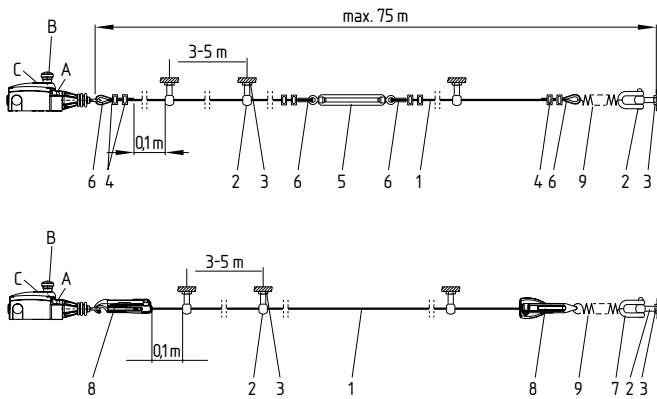

Image 2: mounting of the components

Key

- 1 Pull-wire with red PVC sheath \varnothing 5 mm (steel core: \varnothing 3 mm)
- 2 Eyebolt
- 3 Nut
- 4 Wire clamp
- 5 Tensioner
- 6 Wire thimble
- 7 Shackle
- 8 S900 wire tensioner
- 9 Tension spring RZ-2041
- A Position indication
- B Emergency-Stop button
- C Reset button

We recommend the use of the RZ-2041 tension spring to attenuate the effects of temperature variations. Due to the thermal expansion behaviour of the wire, the maximum authorised wire length is determined by the ambient temperature range (refer to image 3).

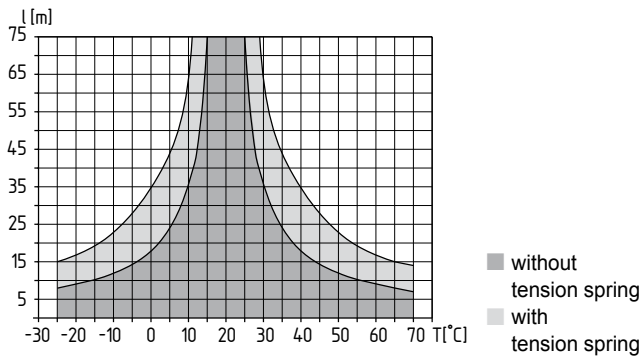

Image 3: temperature-dependent maximum wire length with or without tension spring

The pull-wire must be fixed to the ring and then be pre-tensioned until the position indication is in the central position (refer to image 1).

As the thimbles are subject to deformation in case of wire pull, the wire should be pulled several times after fitting. After that, the wire must be re-tensioned (see image 4).

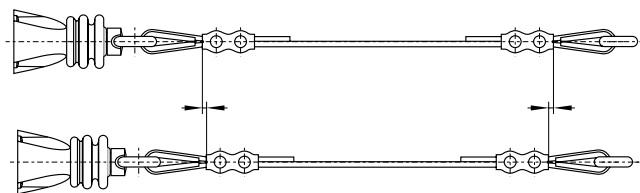

Image 4: deformation of the wire thimbles



In order to ensure an optimal operation safety and to save time during fitting, we recommend using the wire rope and the combined fixing and tensioning system from Schmersal. Alternatively, wire thimbles and wire clamps can be used in conjunction with a tensioner. In this case, the red PVC sheet must be removed in the clamp area prior to installing the wire rope.

3.2 Dimensions

All measurements in mm.

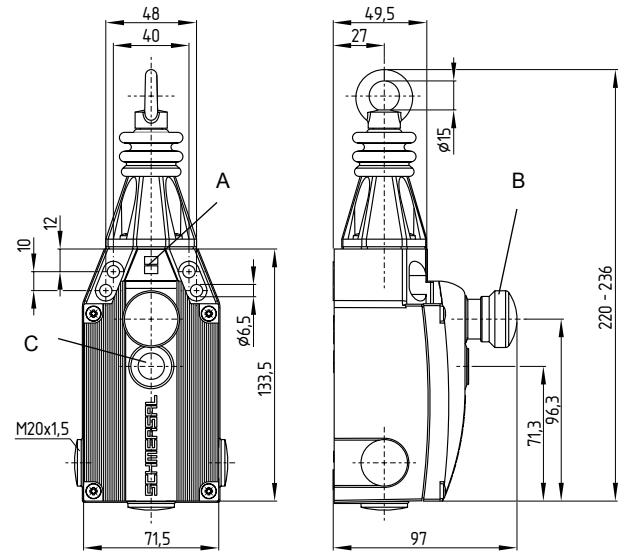

- Key**
- A Position indication
 - B Emergency-Stop button
 - C Reset button

4. Electrical connection

4.1 General information for electrical connection



The electrical connection may only be carried out by authorised personnel in a de-energised condition.

1. Cover screws must be loosened
2. Dust shield cap remove
3. Cable glands M20 x 1.5 with an appropriate degree of protection must be used
4. When wiring, please ensure that no cables are located within the range of the lever system and the pushbutton
5. The inside of the switch must be imperatively cleaned (e.g. removal of cable residues), considering that foreign bodies can affect the switching behaviour
6. Unused cable entries must be sealed by means of locking screws, included in delivery (tightening torque 4 Nm)
7. The cover screws must be tightened uniformly (tightening torque 1 Nm)

Accessories cable gland

- Ordering code: 103006011
- Authorised cable diameter: 6 ... 12 mm
- Tightening torque: 8 Nm

4.2 Contact variants

Contacts shown in a de-energised condition and with the actuator inserted.

ZQ 900-11

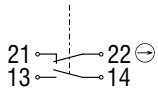

ZQ 900-02

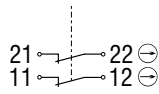

ZQ 900-13

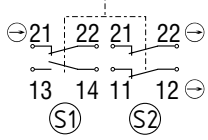

ZQ 900-22

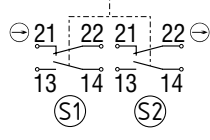

ZQ 900-04

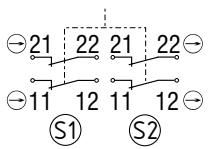

Key ⊖ Positive break NC contact

5. Set-up and maintenance

5.1 Functional testing

The safety function of the safety components must be tested. The following conditions must be previously checked and met:

1. Check the correct fitting of the pull-wire emergency stop switch
2. Check the integrity of the cable entry and connections
3. Check the switch enclosure for damage
4. Check the functionality of the switch by actuating the wire
5. Check the cable tensioning by means of the position indicator

5.2 Maintenance

A regular visual inspection and functional test, including the following steps, is recommended:

1. Check the functionality of the switch by actuating the wire and, if applicable, the emergency stop switch
2. Check the cable entries and the wire connections
3. Remove particles of dust and soiling
4. Check the wire tension through the wire position indication and check the wire and the wire guides for damage and correct fitting

Damaged or defective components must be replaced.

6. Disassembly and disposal

6.1 Disassembly



The safety switchgear must be disassembled in a de-energised condition only.

6.2 Disposal

The safety switchgear must be disposed of in an appropriate manner in accordance with the national prescriptions and legislations.

7. Appendix

7.1 EC Declaration of conformity

	
EC Declaration of conformity	
Translation of the original Declaration of Conformity	ACE Schmersal Eletroeletrônica Industrial Ltda. Av. Brasil, nº 815 Vila Esplanada CEP: 18550-000 Boituva – SP Brazil Internet: www.schmersal.com.br
We hereby certify that the hereafter described products both in their basic design and construction conform to the applicable European Directives.	
Name of the safety component:	ZQ 900
Description of the safety component:	Pull-wire emergency stop switch for safety applications.
Harmonised EC-Directives:	2006/42/EC-EC-Machinery Directive
Person authorised for the compilation of the technical documentation:	Oliver Wacker Möddinghofe 30 42279 Wuppertal
Place and date of issue:	Boituva, December 3, 2015
	
	Authorised signature Marco Antonio De Dato Head of Engineering and Design

ZQ900-E-EN



The currently valid declaration of conformity can be downloaded from the internet at www.schmersal.net.



K.A. Schmersal GmbH & Co. KG
Möddinghofe 30, D - 42279 Wuppertal
Postfach 24 02 63, D - 42232 Wuppertal

Phone +49 - (0)2 02 - 64 74 - 0
Telefax: +49 - (0)2 02 - 64 74 - 1 00
E-Mail: info@schmersal.com
Internet: <http://www.schmersal.com>

Production site:
ACE Schmersal
Eletroeletrônica Industrial Ltda.
Av. Brasil, nº 815
Jardim Esplanada – CEP: 18550-000, Boituva – SP
Brazil
Phone +55 - (0)15 - 32 63 - 9866
Fax +55 - (0)15 - 32 63 - 9890
E-Mail: vendas@schmersal.com.br
Internet: <http://www.schmersal.com.br>

K.A. Schmersal GmbH & Co. KG
Möddinghofe 30, D - 42279 Wuppertal
Postfach 24 02 63, D - 42232 Wuppertal

Phone +49 - (0)2 02 - 64 74 - 0
Telefax: +49 - (0)2 02 - 64 74 - 1 00
E-Mail: info@schmersal.com
Internet: <http://www.schmersal.com>

Production site:

ACE Schmersal

Eletroeletrônica Industrial Ltda.

Av. Brasil, nº 815

Jardim Esplanada – CEP: 18550-000, Boituva – SP

Brazil

Phone +55 - (0)15 - 32 63 - 9866
Fax +55 - (0)15 - 32 63 - 9890
E-Mail: vendas@schmersal.com.br
Internet: <http://www.schmersal.com.br>